

DE20801T2
 BIOCLIP
 ELECTRONIC BASIN MIXER

DELABIE

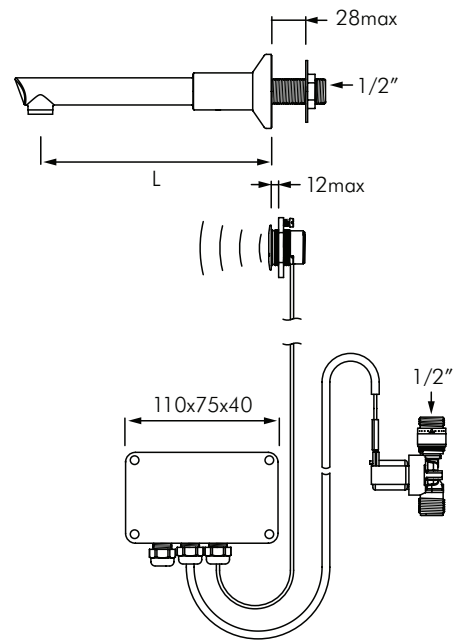

DESCRIPTION

DELABIE DE20801T2 is a wall mounted electronic basin tap with independent IP65 electronic control unit and shock-proof infrared sensor. Available as 230/12V mains supply with transformer. Anti-bacterial duty flush operates for ~60 seconds every 24 hours after last use. Flow rate is limited to 5L/min at 300kPa. Operating pressure is 100-500kPa, 300kPa recommended. Supplied with one disposable Hostaform spout L.125mm or two removable chrome plated stainless steel spouts L.138mm with hygienic scale-resistant flow straightener. Base and spout have smooth interior and low volume of water (limits bacterial niches). Biofil sterile spout is also available for this tap, see separate BIOFIL information.

Two shut off modes: 1) Standard mode: timed flow with automatic shut off; 2) On/Off mode: user shuts off voluntarily or automatic shut off after 30 minutes.

Supplied with M1/2" solenoid valve and filter.

We recommended installing a thermostatic mixing valve (see Water Tempering section).

INSTALLATION

- Wall mounted connection M1/2".
- Maximum Hot water temperature 55°C.
- 230V AC power connection to control box.
- Solenoid and spout connect to 1/2" water supply.
- Flow rate limited to 5L/min at 300kPa.
- Different spout options; 1x disposable Hostaform spout, 2x chrome plated stainless steel removable spouts, 1x BIOFIL sterile filter spout.

MODELS

- DE20801T2** - Standard model 5L/min with disposable spout L.125 - 6 star WELS rating.
- DE20804T2** - Same as DE20801T2 but with 2 removable stainless steel BIOCLIP spouts L.138.

