

DE2445 SECURITOUCH WALL MOUNTED BASIN MIXER

DELABIE

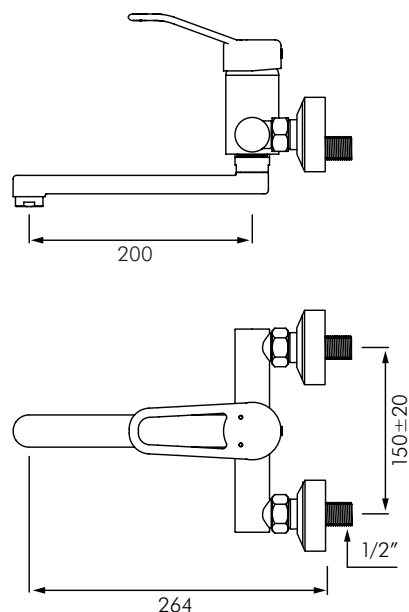

DESCRIPTION

DELABIE DE2445 is a wall mounted mechanical basin/sink mixer with Securitouch thermal insulation to prevent burns. Pre-set maximum temperature limiter. Equalised Pressure (EP) cartridge option also available. EP cartridge delivers nearly constant water temperature despite pressure fluctuations in either the hot or cold water supply lines giving anti-scald protection to the user. Flow rate 5L/min at 300kPa, can be adjusted via the stopcocks. Operating pressure is 100-500kPa, 300kPa is recommended. Chrome plated solid brass body and spout with smooth interiors and low water volume (reduces bacterial development), with sculptured control lever. Supplied with two offset wall connectors that have integrated stopcocks and purge valves. Flat, swivel L.200mm spout with hygienic flow straightener is suitable for fitting BIOFIL terminal filter (see separate BIOFIL information).

Supplied with PEX flexibles, M1/2" connections and reinforced fixing.

INSTALLATION

- Wall mounted M1/2" connections 150mm centres.
- Supplied with offset stopcock/purge connectors.
- Preset maximum temperature limiter.
- Ø40mm ceramic cartridge.
- Flow rate 5L/min at 300kPa, can be adjusted via stop/purge connectors.
- Flat, swivel under spout L.200mm with hygienic flow straightener.

MODELS

- DE2445** - Standard model 16L/min.
- DE2445L** - Same as DE2445 but with L.150mm Hygiene control lever.
- DE2445EP** - Same as DE2445 but with EP cartridge.
- DE2445LEP** - Same as DE2445EP but with L.150mm Hygiene control lever.