

SPECIFICATION SUBMITTAL SHEET



P1500



P1520



P1550

FEATURES

Sizes: 1/2" 3/4"

Maximum working water pressure 175 PSI
 Maximum working water temperature 210°F
 Hydrostatic test pressure 175 PSI
 Threaded connections (MNPT x FNPT) ANSI B1.20.1
 (Available 1/2" FNPT outlet only)

OPTIONS

- P1500 - calibrated adjustments from 25 to 175 psi
- P1520 - with 50, 75, 100 and 125 psi relief settings
- P1550 - with 75 psi and 125 psi relief setting (imported)

ACCESSORIES

- Water Hammer Arrester (Model 1250)
- Water Pressure Reducing Valve (Model BR4)
- Vacuum Relief Valve (Model VR10)

APPLICATION

Designed for installation on cold water service lines as a means of protection against excessive pressure buildup. These devices are for pressure only and should be used in conjunction with other temperature limiting devices. Also suitable for static relief, low capacity pump relief, passive solar, thermal expansion relief and other similar uses in commercial and industrial applications.

MATERIALS

Main valve body Cast Bronze
 Access covers Brass
 Internals Stainless Steel
 Brass
 Elastomers Silicone
 Buna Nitrile
 Springs Stainless steel

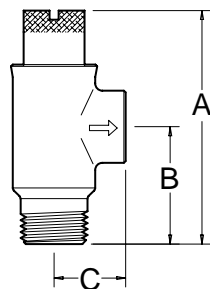

P1500

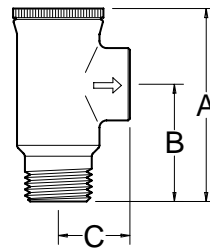

P1520

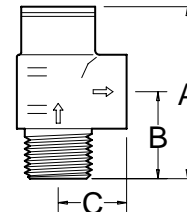

P1550

DIMENSIONS & WEIGHTS (do not include pkg.)

MODEL	SIZE		PRESSURE RANGE		DIMENSIONS (approximate)						WEIGHT	
	in.	mm	psi	kpa	A		B		C		lbs.	kg.
					in.	mm	in.	mm	in.	mm		
P1500	1/2	15	25 to 175	170 to 1200	3 3/8	86	1 1/4	32	1	25	1/2	0.20
P1500	3/4	20	25 to 175	170 to 1200	3 3/8	86	1 1/4	32	1	25	1/2	0.20
P1520	1/2	15	50 to 125	340 to 860	2 1/2	64	1 1/4	32	1	25	1/2	0.20
P1520	3/4	20	50 to 125	340 to 860	2 1/2	64	1 1/4	32	1	25	1/2	0.20
P1550	1/2	15	75 & 125	515 & 860	2 5/16	59	1 1/4	32	7/8	22	1/2	0.20
P1550	3/4	20	75 & 125	515 & 860	2 5/16	59	1 1/4	32	7/8	22	1/2	0.20

TYPICAL INSTALLATION

Local codes shall govern installation requirements. Unless otherwise specified, the assembly shall be mounted in accordance with the manufacturers' instructions and the latest edition of the Uniform Plumbing Code. Assembly shall be installed with adequate drain and sufficient side clearance for testing and maintenance. The installation shall be made so that no part of the unit can be submerged or where relief valve discharge could cause damage.

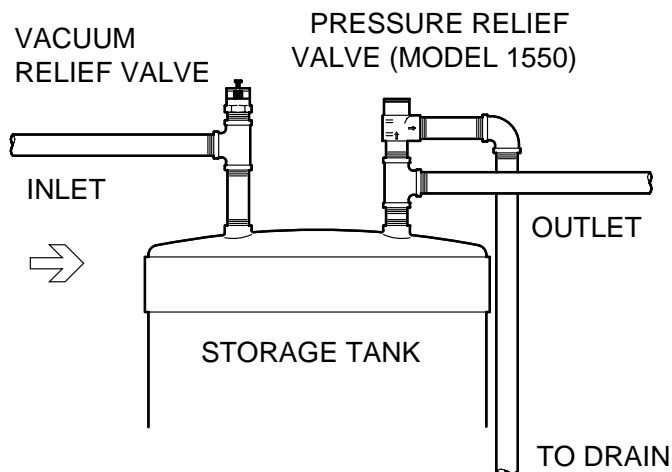

TYPICAL INSTALLATION

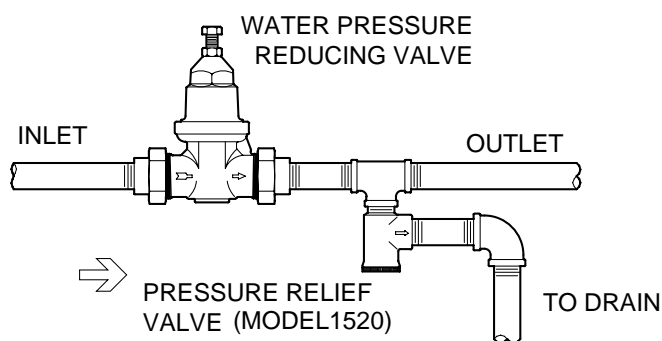

TYPICAL INSTALLATION

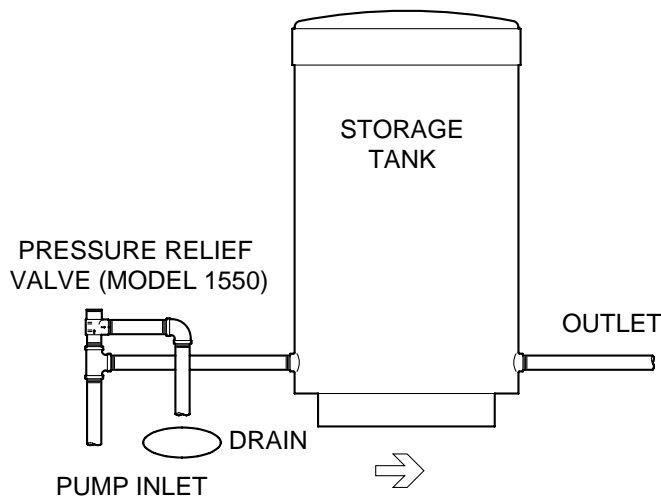

TYPICAL INSTALLATION

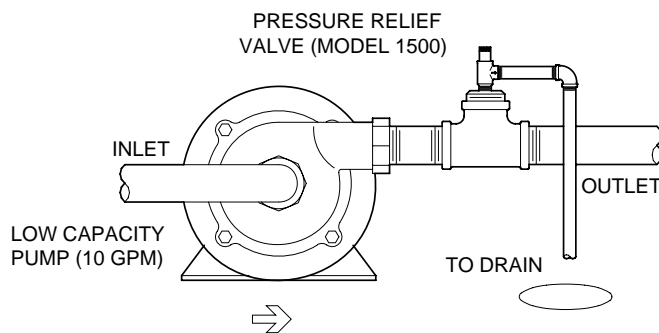

TYPICAL INSTALLATION

SPECIFICATIONS

The Pressure Relief Valve shall consist of a bronze body, and an internally-loaded "poppet" type pressure sensing member. The main body shall have a male pipe thread on the inlet and a female pipe thread on the outlet. The Pressure Relief Valve shall be a WILKINS Model P1500, P1520 or P1550.