



Wisa XS Inwall Cisterns

MODELS FEATURE:

- Framed and unframed cisterns
- Quality metal push plates
- Vandal resistant pneumatic push plates
- Low flush volume dual flush



**MACDONALD
INDUSTRIES LIMITED**

WISA XS FRAMED CISTERN

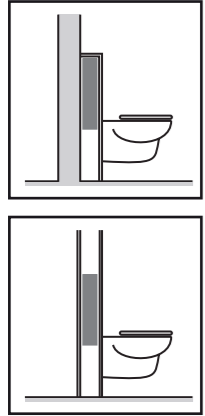

WISA XS FRAMED CISTERN

- Pre-assembled cistern with structural support frame suitable for use with all wall hung WCs.
- 3/6L dual flush achieving a WELS 3 Star rating with compatible toilets
- Height adjustable frame to allow for variations in finished floor height (overlay floors, tiles etc) or for accessible WC mounting height.
- Includes noise insulation kit behind WC
- Quiet hydraulic float valve
- Quality European made product
- Access through front push panel for all repairs

Uses either mechanical XS push plates or pneumatic push plates where client is looking for a softer feel to the button and an easier push.

Also available in a vandal resistant version (see separate literature) to suit public buildings. ref **WS2701VP**.

Suitable for use with:
 WISA Medica disabled wall hung WC ref WS1946
 KALEVIT Single Piece wall hung WC ref KV29363
 FRANKE wall hung WCs ref FRWM2 or FRWM3

Product Code: WS2701

- Specify push panel separately - refer Page 4
- Where cistern to pan inlet connection dimension exceeds 170mm (WISA Medica) specify longer 500mm inlet pipe, ref WS1201.

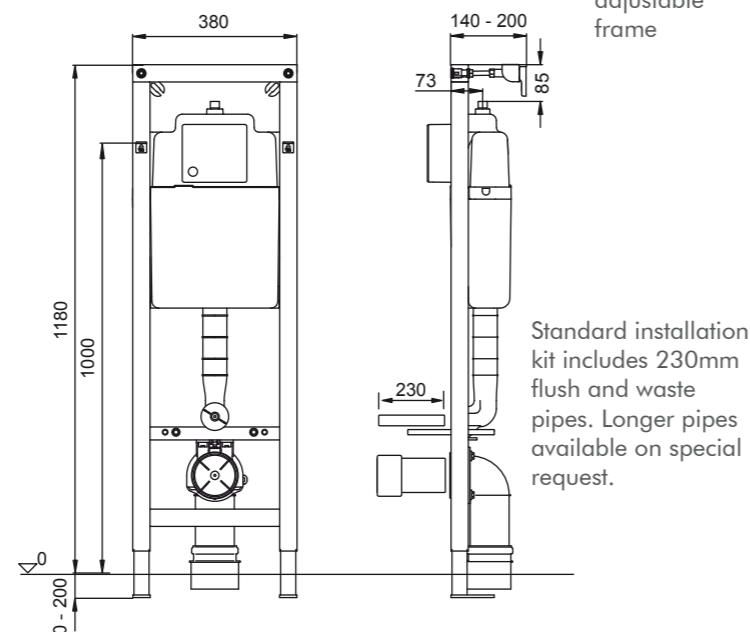
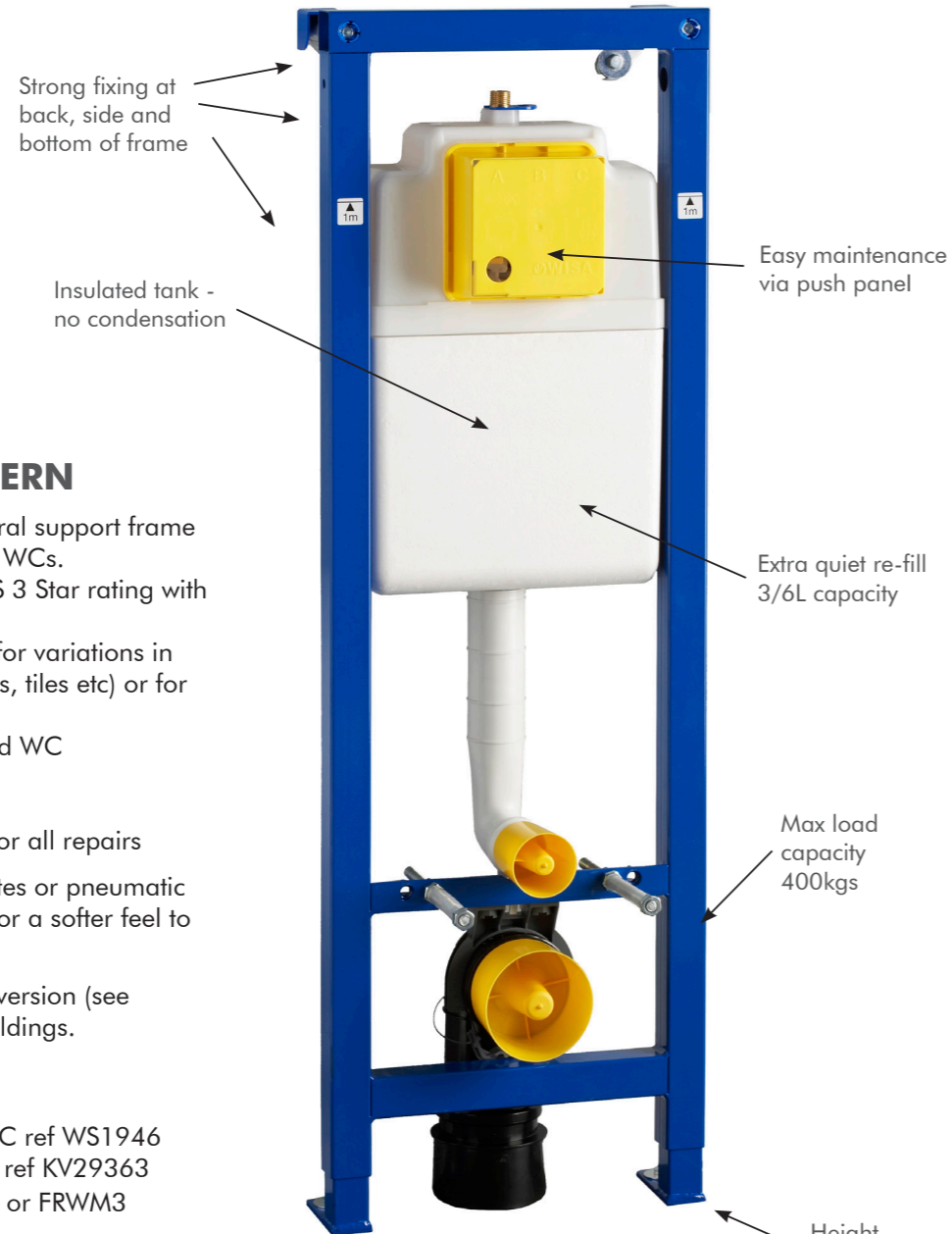

WISA XS INWALL CISTERN

Pre-plumbed and pressure tested for a perfect installation every time

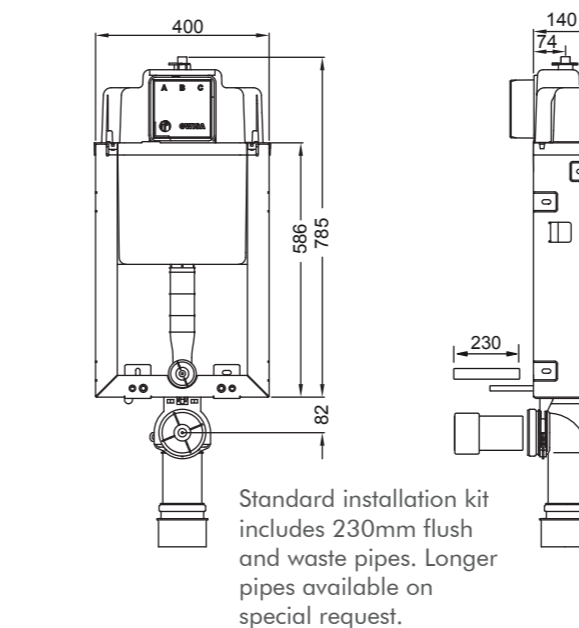

WISA XS MONT CISTERN

- Pre-assembled cistern with galvanised steel mounting frame
- 3/6L dual flush achieving a WELS 3 Star rating with compatible toilets
- Includes noise insulation kit behind WC
- Quiet hydraulic float valve
- Quality European made product
- Access through front push panel for all repairs
- Suitable for use with floor mounted back to wall pans

Also available in a vandal resistant version (see separate literature) to suit public buildings ref: **WS2104VP**.

Uses either mechanical XS push plates or pneumatic push plates where client is looking for a softer feel to the button and an easier push.

Suitable for use with:
 FRANKE stainless steel WCs ref FRFM2 or FRFM5

Product Code: WS2104

- Specify push panel separately - refer Page 4
- Where cistern to pan inlet connection dimension exceeds 170mm (FRFM5) specify longer 500mm inlet pipe, ref WS1201.



PUSH PANELS

DELOS Dual Flush Mechanical Push Panels

Vandal resistant version available using stainless steel push buttons, suitable for use in public buildings. Refer separate literature.

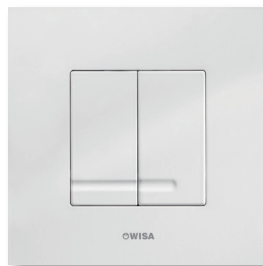

WHITE ABS PLASTIC
160 x 160
Product Code: WS5601



BRIGHT CHROME METAL ALLOY
160 x 160
Product Code: WS4051



MATT CHROME METAL ALLOY
160 x 160
Product Code: WS4031

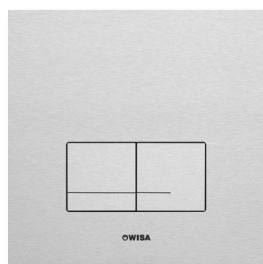

NATURAL ALUMINIUM
160 x 160
Product Code: WS0111

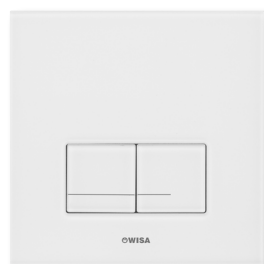

SATIN STAINLESS STEEL
160 x 160
Product Code: WS0101

LUGA Dual Flush Pneumatic Push Panel

Pneumatic push plates are supplied with pneumatic actuators and tubing allowing cistern tank change over from mechanical to pneumatic activation.

WS4238 buttons are supplied with 2m tubing allowing remote mounting of buttons on panels (by others).

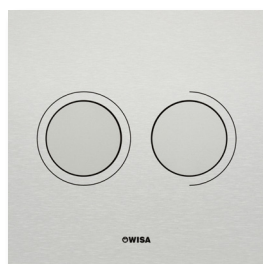

ALUMINIUM 160 x 160
Product Codes:
Natural - WS9745
Black - WS9738



GLASS 160 x 160
Product Codes:
White - WS9801
Black - WS9838



BLANK PANEL
Must be used for access to service cistern when WS4238 buttons are used



STAINLESS STEEL
66 dia button
Product Codes:
Single flush - WS4238SF
Dual flush - WS4238DF