

JRG

+GF+

JRG Valves

JRGUMAT

Thermostatic Mixing Valve



JRGUMAT – Mixed water temperature without auxiliary energy

The proven JRGUMAT thermoblending valves are thermostatically regulating mixing valves, which are used everywhere where a constant mixed water temperature of high control accuracy is desired or required.

+ Properties

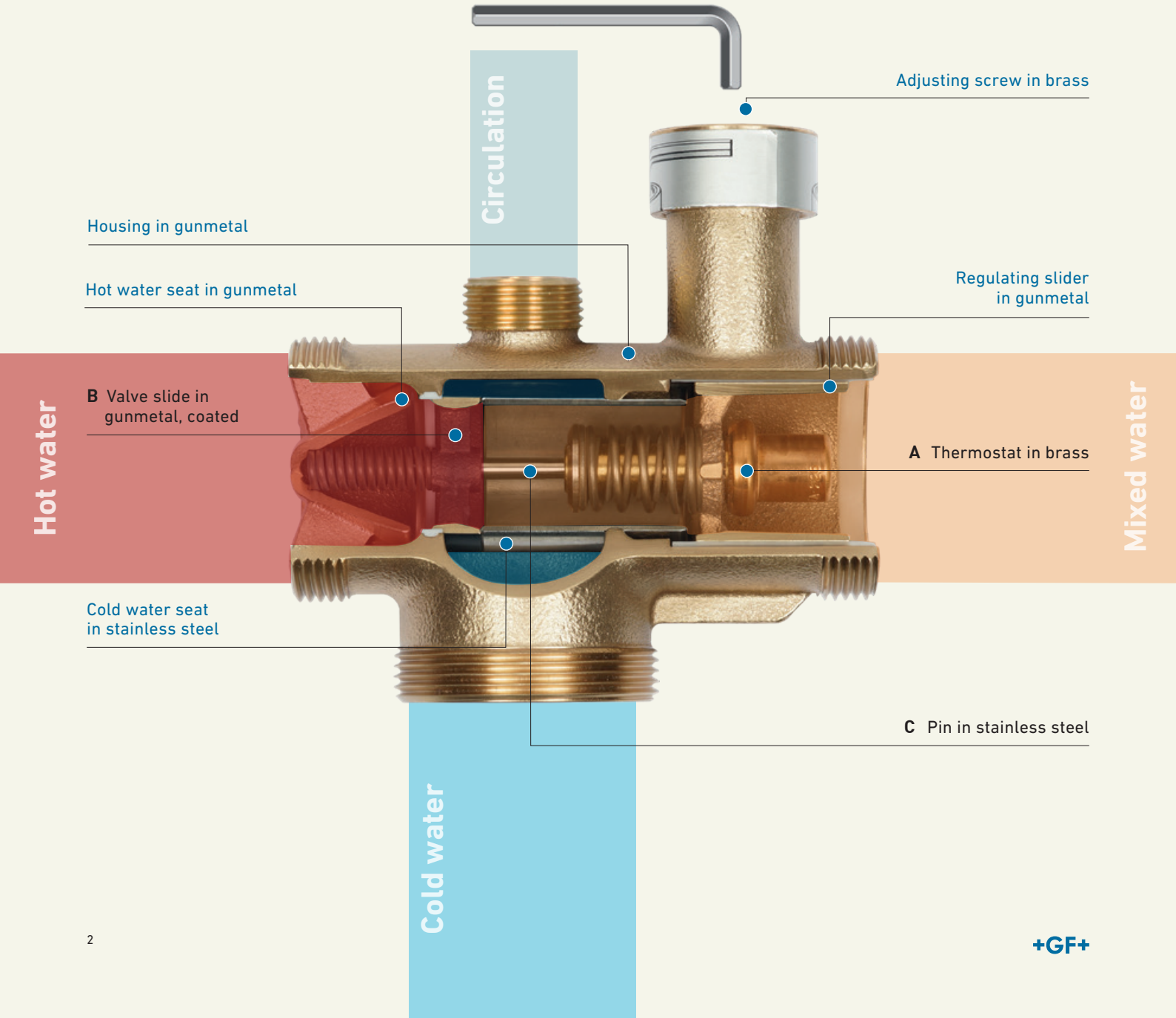

The JRGUMAT thermostatic mixing valve is a three-way valve made of gunmetal, which proportionally regulates the mixed water temperature without the need for auxiliary energy.

The mixed water temperature is transferred to thermostat **A**, which compares it with the set target value. If the water temperature does not match the target value, a volume change is triggered in thermostat **A**. Valve slide **B** is now moved by pin **C** until the temperature of the mixed water matches the target value. The JRGUMAT valve is also used as a thermal switch.

For safe operation and maintenance, the valves as shown in the installation examples below are required.

Fields of Application

The well-proven JRGUMAT thermostatic mixing valves are thermostatically controlled mixing valves which are used whenever a constant mixed water temperature and high control accuracy are desired or required, e.g. as central mixing valve in detached houses and apartment buildings, hospitals, nursing homes, hotels, barracks, shower rooms of sports facilities, industrial and commercial buildings.

JRGUMAT thermostatic mixing valves also serve as excess temperature protection in systems using alternative forms of energy such as solar systems, firewood heating, wood chip furnaces, pellet heating, etc. Thanks to their high control accuracy, JRGUMAT thermostatic mixing valves can also be used for special applications, e.g. as controller for high-temperature maintenance.

Hot water temperature

To ensure proper function of the JRGUMAT thermostatic mixing valve, the hot water temperature should be at least 5K higher than the desired mixed water temperature. Furthermore, identical hydraulic conditions at the hot and cold water inlets are crucial for the mixing valve to function properly. This is ensured by installing the mixing valve in the water heater circuit in accordance with our installation examples.

+ Advantages

- Delivers mixed water at constant temperature
- High control accuracy
- Operates without auxiliary energy
- Protects from scalding
- Saves energy
- Increases comfort and safety in the hot water system

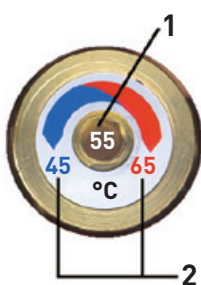

| 1 Factory settings Default temperature °C | 2 Mixed water Adjustment ranges °C | Adjustment of the mixed water temperature per full turn of the key | | |
|---|--|--|----------------------|----------|
| | | GN ½ -1 DN 15-25 | GN 1¼ -2 DN 32-50 | DN 65/80 |
| 25 | 20-30 | | | |
| 40 | 30-45 | | | |
| 48 | 36-53 | ca. 6 K | ca. 4 K | ca. 2 K |
| 55 | 45-65 | | | |
| 70* | 60-80 | | | |

* only available as type 3400

Nomogram for JRGUMAT thermostatic mixing valves 3400 and 3410

The determined pipe dimension is also considered nominal width DN for the JRGUMAT thermostatic mixing valve. Relations of volume flow, nominal width and pressure drop may also be determined with the help of this nomogram. The greyshaded area provides optimal operating conditions.

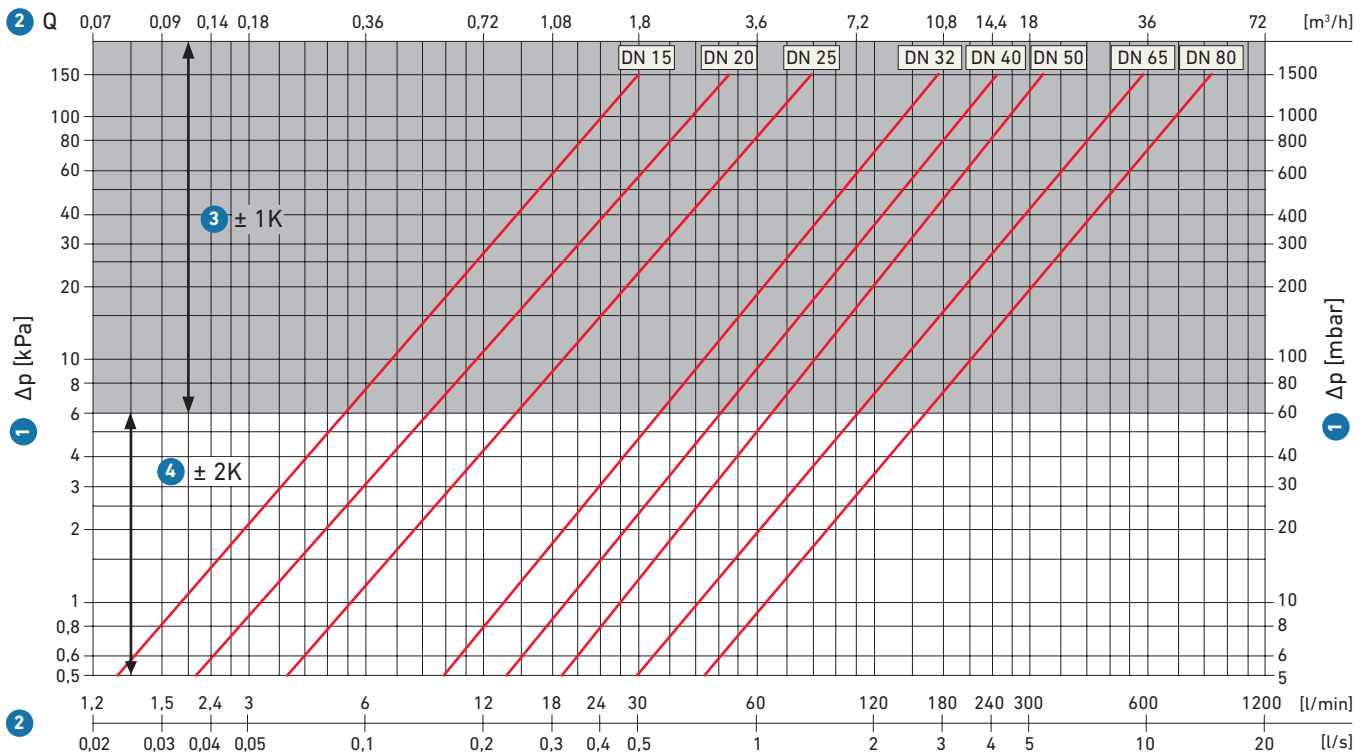

- ① Pressure drop
- ② Flow rate
- ③ Setpoint tolerance $\pm 1\text{K}$
- ④ Setpoint tolerance $\pm 2\text{K}$

Noise behaviour

| Dimensions | GN ½ | DN 15 | GN ¾-1¼ | DN 20-32 |
|-------------|------|-------|---------|----------|
| Valve group | I | | II | |

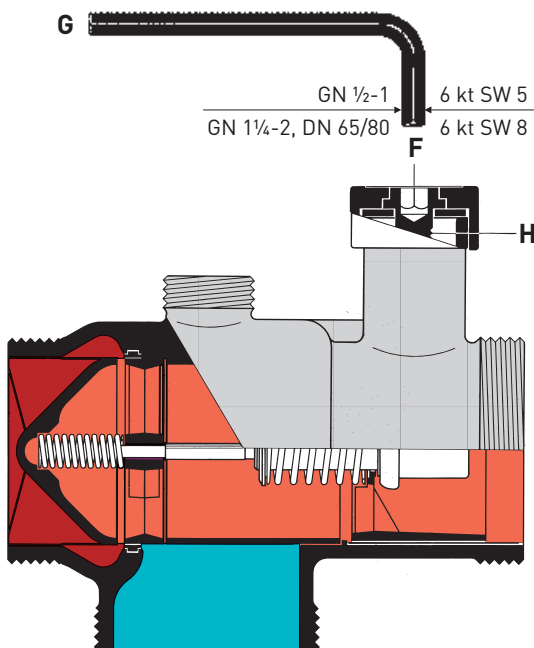

Factory settings/Adjustment

JRGUMAT thermostatic mixing valves come with a thermostat whose temperature is factory-set at a default value which can be taken from the temperature plate **F** on the valve and on the packaging. This default temperature may only be changed within the limits of the assigned temperature range.

The procedure is as follows:

Use the Allen key **G** to pierce the temperature plate **F** in the middle. Turn the screw **H** clockwise to increase and counter-clockwise to decrease the temperature of the mixed water. The volume flow must be within the greyshaded area "Setpoint tolerance $\pm 1\text{K}$ " (see nomogram).



Installation Instructions/ Maintenance/Transport Packaging

Installation instructions

Follow the installation examples and observe local standards and guidelines when installing your JRGUMAT valve. The JRGUMAT thermostatic mixing valve can be mounted in any position.

Install only valves (Y-valves, back flow preventers, etc.) with low pressure drop. Thoroughly flush the supply line before installing the JRGUMAT thermostatic mixing valve.

To prevent the mixing valve from malfunctioning, install it side by side with the heater and provide it with a 15 cm high thermosiphon. The unions listed on page 11 are obligatory. Do not use unions sealing in the thread (e.g. hemp). AFM 34 gaskets must not be oiled or greased.

Back flow prevention

Install only low pressure drop check valves 1610 to 1615 and 1650, swing check valve 1682 and lockable back flow preventers 5262 to 5284.

Soldered union

During soldering, the solder-joint unions must be separated from the mixing valve, as the thermostat and the gaskets may otherwise be damaged.

Maintenance

- JRGUMAT thermostatic mixing valves are virtually maintenance-free.
- The installation and operating instructions are to be handed over to the building owner or plant operator on delivery.
- In case of trouble please check your installation with the help of the installation diagrams in this brochure.
- Replace the mixing valve in case of malfunctions due to clogging or calcification of the valve.

Transport packaging

After installing and adjusting the valve, the transport packaging of the JRGUMAT thermostatic mixing valve is used as thermal insulation and can be delivered as spare parts.

- Thermal conductivity $\lambda_D = 0.033 \text{ W/mK}$
- Fire behaviour (BKZ) 5.1/B1
- Application temperature $\leq 90^\circ\text{C}$

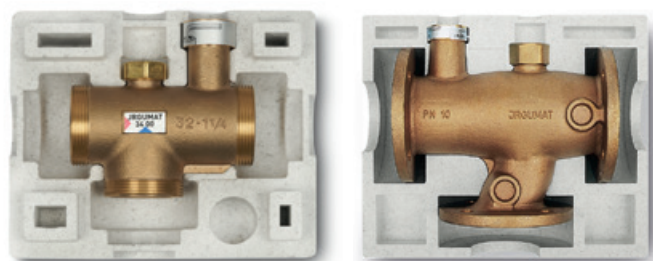

Overview of circulation valves used in building services

Static Circulation Valves



6310
Regulation socket



6335
Needle valve

Dynamic Circulation Valves



6320 JRGUTHERM
Thermostatic circulation valves































6325 JRGUTHERM 2T
Double thermostatic circulation valve for regulated normal and disinfection operation



Hycleen Automation System
9900 Hycleen Automation Master
9910 JRG LegioTherm 2T
Circulation controller for automatic, logged hydraulic balancing and thermal disinfection

Installation Examples with JRGUMAT Thermostatic Mixing Valves

Legend

| JRG Code | | Text | EN 806-1 |
|-----------|---|---|---|
| - | | PWC potable water, cold |  |
| - | | PWH potable water, hot |  |
| - | | PWH-C potable water, hot, circulation |  |
| - | | PWH-M potable water, hot, mixed water |  |
| 3400/3410 |  | JRGUMAT thermostatic mixing valve |  |
| 1300-1310 |  | Pressure reducing valve |  |
| 1350-1360 |  | Pressure reducing valve with filter |  |
| 5200-5234 |  | Shut-off valve |  |
| 1610-1615 |  | Back flow preventer (controllable) |  |
| 5262-5284 |  | Shut-off valve with integrated back flow preventer (controllable) |  |
| 1025/1028 |  | Spring loaded safety valve |  |
| 6310-6325 |  | Circulation valve |  |
| - | | Liquid pump with mechanical drive |  |
| 6000-6013 |  | Ball valve |  |
| 1812 |  | Mechanical filter |  |
| - | | Driven by electric motor |  |
| - | | Driven by electric solenoid (currentless open) |  |
| - | | Timer |  |
| - | | Regulated speed |  |

Notes

- 1-8** The installation examples are recommendations; we do not assume any responsibility for their completeness. Adhere to local standards and guidelines when installing safety devices, equipment and valves. These installation examples serve as guidelines only and should not be relied upon as a substitute for professional advice.
- 2-5+7** Flow path A = to avoid overheating, regulation socket 6310
Flow path B = to cover the heat loss, JRGUTHERM 6320
- 5** Thermal and proportional distribution of the flow rates. Control of the flow rates for the flow paths A and B with JRGUMAT. Size of the circulation valve as a function of circulation losses.
- 6+7** To ensure thermal disinfection, each tapping point must be flushed.
For thermal disinfection sufficient hot water must be available.
Please note: Scalding hazard during thermal disinfection. Thermal disinfection is possible only with a JRGUTHERM 2T circulation valve or with the Master Hycleen Automation JRG LegioTherm 2T.

Installation Examples with JRGUMAT Thermostatic Mixing Valves

1

Observe legend/notes!

Mixed water installation with circulation

*option

Option: Hot water outlet

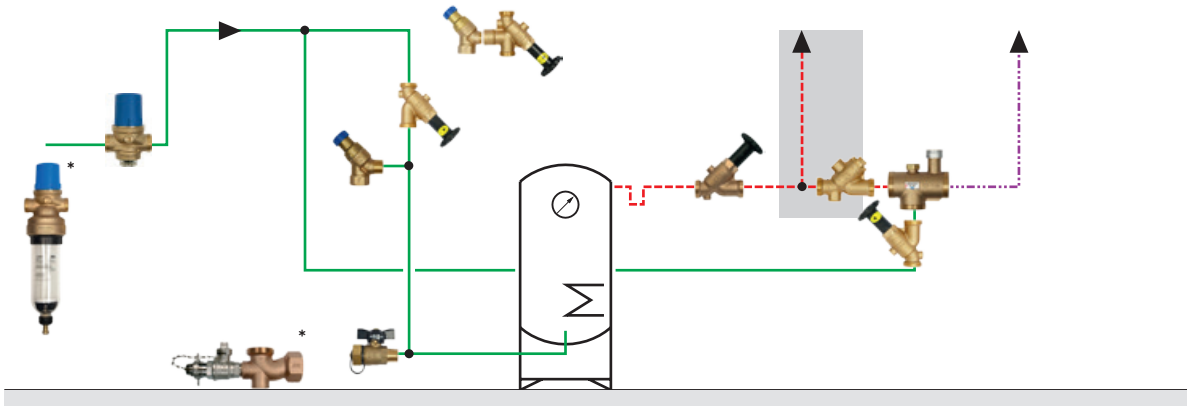

2

Observe legend/notes!

Mixed water installation with circulation
(Flow path A via cold water inlet of the mixing valve)

*option

Option: Hot water outlet

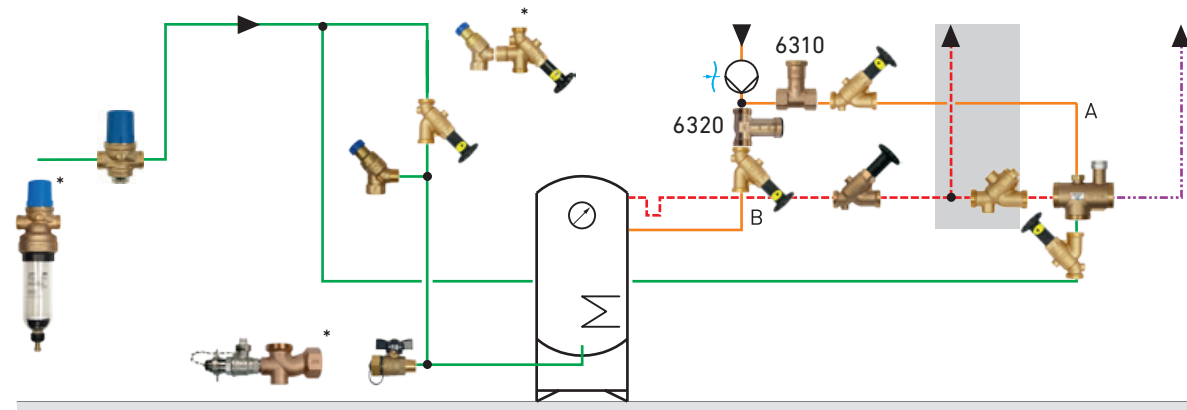

3

Observe legend/notes!

Mixed water installation with two circuits

*option

Option: Hot water outlet with circulation

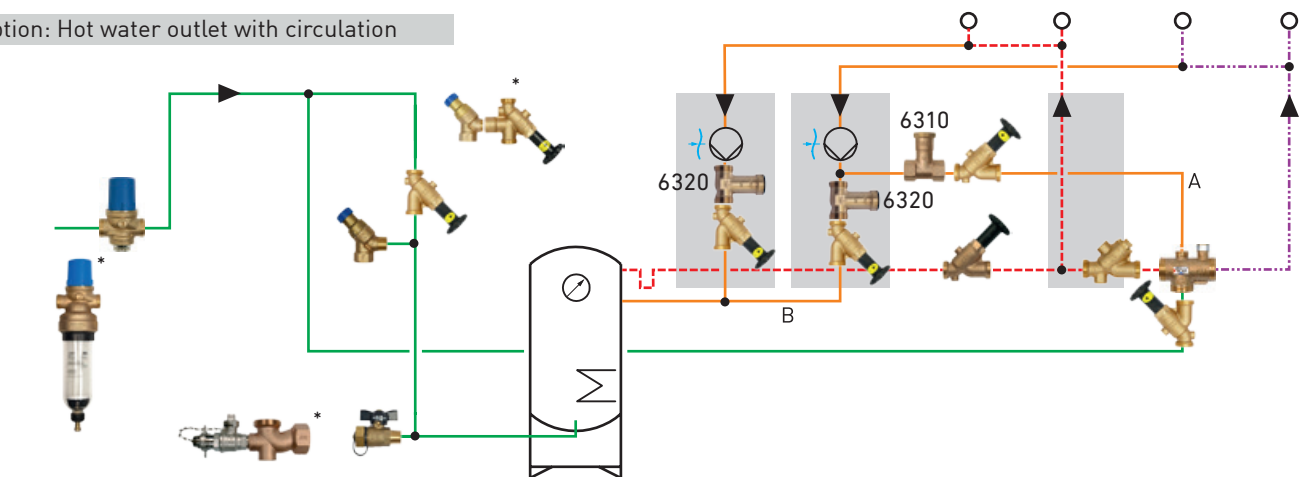

Installation Examples with JRGUMAT Thermostatic Mixing Valves

4 Observe legend/notes!

Mixed water installation with circulation pipe $\geq 3/4''$ *option

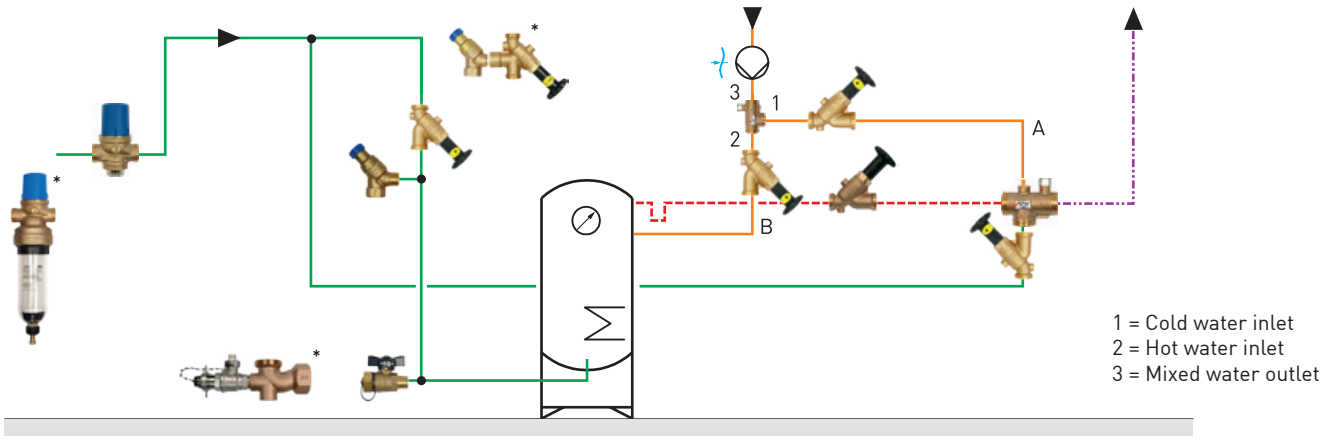

5 Observe legend/notes!

Mixed water installation with thermal disinfection *option

Option: Hot water outlet

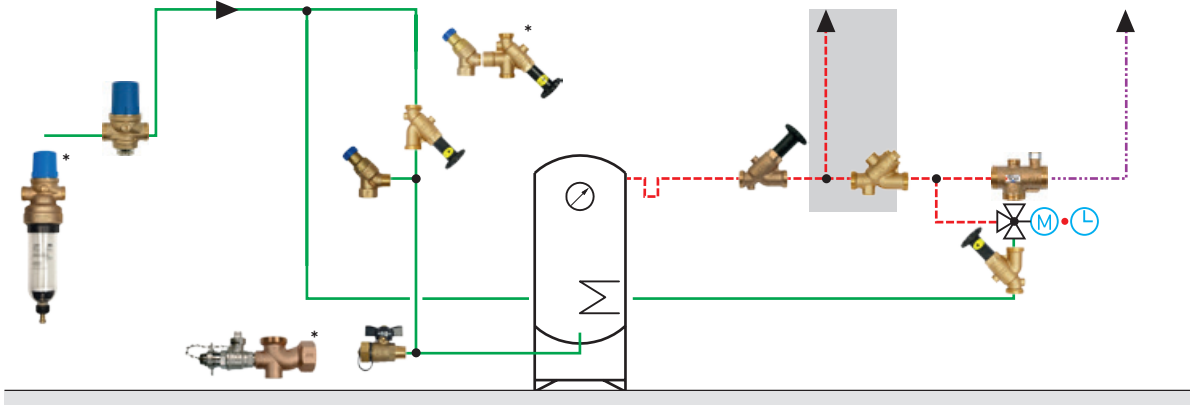

6 Observe legend/notes!

Mixed water installation with circulation and thermal disinfection *option

Option: Hot water outlet

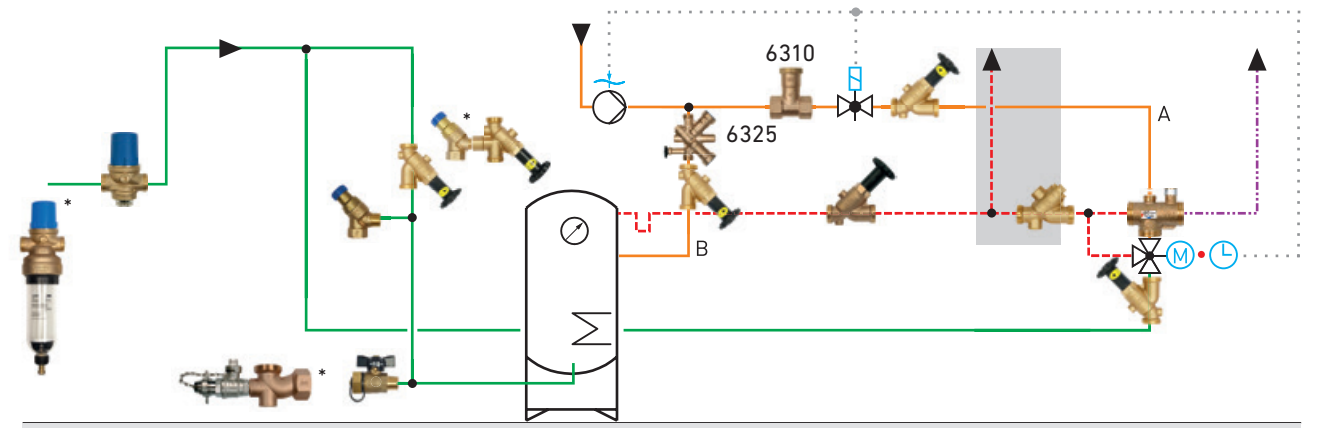

Installation Examples with JRGUMAT Thermostatic Mixing Valves

7 Observe legend/notes!

Regulating the storage capacity with JRGUMAT

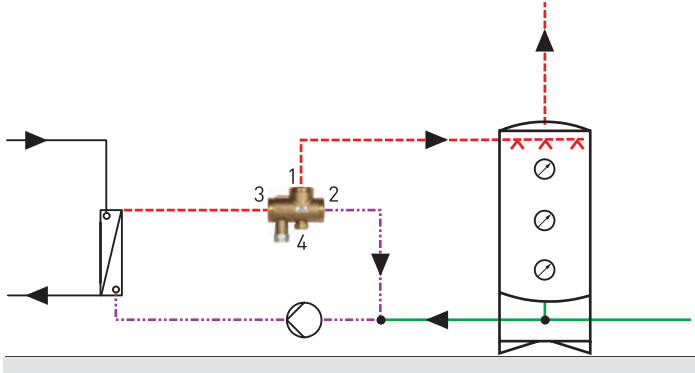

8 Observe legend/notes!

Fixed setpoint control at constant temperature (heating)

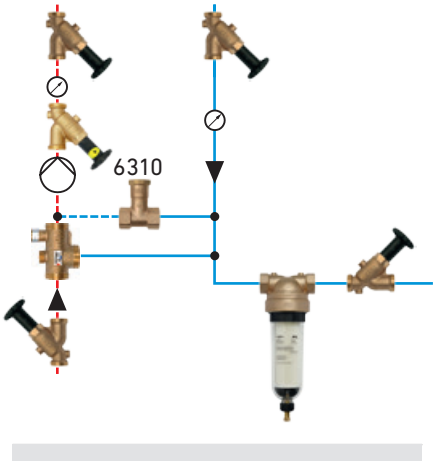

Overview Unions for JRGUMAT Thermostatic Mixing Valve 3400

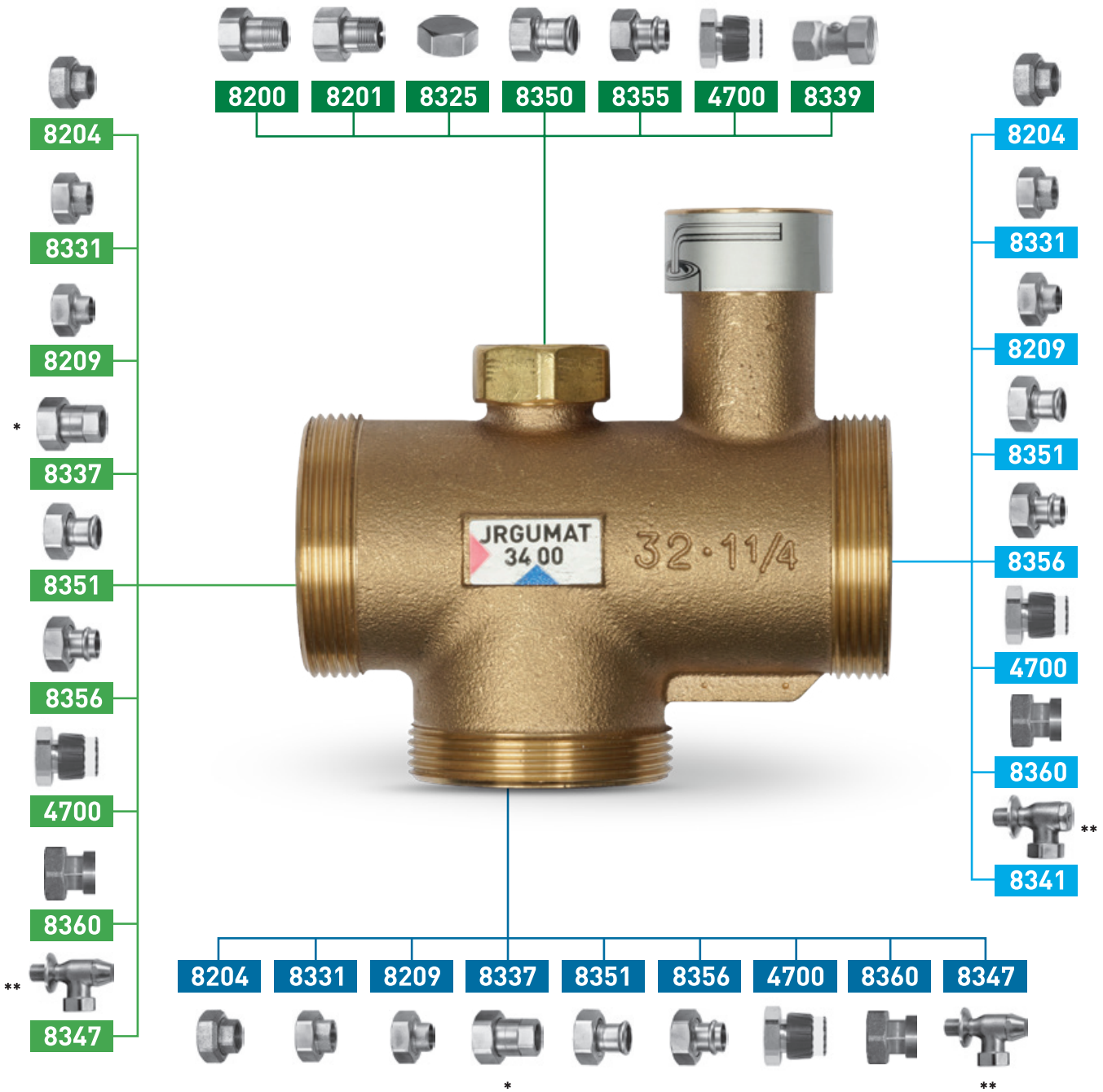

Use only the unions listed below.
AFM 34 gaskets must not be oiled or greased.

* Union 8337 with check valve only for
GN ½ (DN 15), or GN 15 (DN12) and
GN ¾ (DN 20), or GN 22 (DN 20).

** Elbow union 8341 and angle valve 8347
only for max. ½ (DN 15).

Installation example

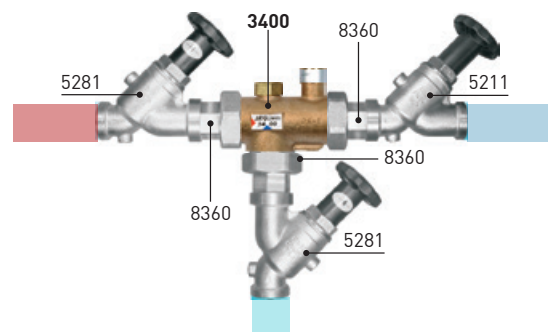

Overview Unions for JRGUMAT Thermostatic Mixing Valves 3410

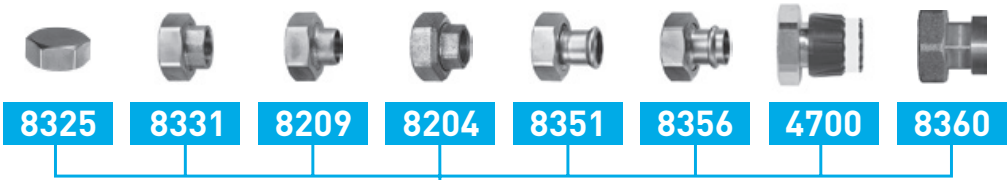

JRGUMAT 3400

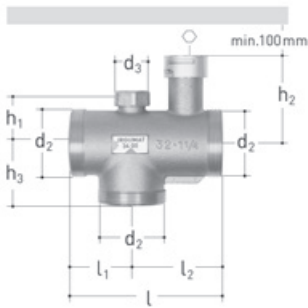

JRGUMAT Thermostatic mixing valve gunmetal

- Temperature: max. 90°C
- Factory setting: 25 / 40 / 48 / 55 / 70°C (adjustable)
- Material: gunmetal
- Connection: male thread

| DN (mm) | Thread Type | Size (inch) | range (°C) | Temperature (°C) | JRG Code | GF Code | Weight (kg) |
|------------|-------------|----------------|---------------|---------------------|-----------------|--------------------|----------------|
| 15 | GN | ½ | 20 - 30 | 25 | 3400.910 | 350 760 511 | 0.530 |
| 15 | GN | ½ | 30 - 45 | 40 | 3400.912 | 350 760 512 | 0.530 |
| 15 | GN | ½ | 36 - 53 | 48 | 3400.914 | 350 760 517 | 0.530 |
| 15 | GN | ½ | 45 - 65 | 55 | 3400.916 | 350 760 513 | 0.530 |
| 15 | GN | ½ | 60 - 80 | 70 | 3400.918 | 350 760 514 | 0.530 |
| 20 | GN | ¾ | 20 - 30 | 25 | 3400.920 | 350 760 411 | 0.700 |
| 20 | GN | ¾ | 30 - 45 | 40 | 3400.922 | 350 760 412 | 0.700 |
| 20 | GN | ¾ | 36 - 53 | 48 | 3400.924 | 350 760 417 | 0.700 |
| 20 | GN | ¾ | 45 - 65 | 55 | 3400.926 | 350 760 413 | 0.700 |
| 20 | GN | ¾ | 60 - 80 | 70 | 3400.928 | 350 760 414 | 0.700 |
| 25 | GN | 1 | 20 - 30 | 25 | 3400.930 | 350 760 311 | 0.910 |
| 25 | GN | 1 | 30 - 45 | 40 | 3400.932 | 350 760 312 | 0.910 |
| 25 | GN | 1 | 36 - 53 | 48 | 3400.934 | 350 760 317 | 0.910 |
| 25 | GN | 1 | 45 - 65 | 55 | 3400.936 | 350 760 313 | 0.910 |
| 25 | GN | 1 | 60 - 80 | 70 | 3400.938 | 350 760 314 | 0.910 |
| 32 | GN | 1 ¼ | 20 - 30 | 25 | 3400.940 | 350 760 211 | 1.630 |
| 32 | GN | 1 ¼ | 30 - 45 | 40 | 3400.942 | 350 760 212 | 1.630 |
| 32 | GN | 1 ¼ | 36 - 53 | 48 | 3400.944 | 350 760 217 | 1.630 |
| 32 | GN | 1 ¼ | 45 - 65 | 55 | 3400.946 | 350 760 213 | 1.630 |
| 32 | GN | 1 ¼ | 60 - 80 | 70 | 3400.948 | 350 760 214 | 1.630 |
| 40 | GN | 1 ½ | 20 - 30 | 25 | 3400.950 | 350 760 111 | 2.140 |
| 40 | GN | 1 ½ | 30 - 45 | 40 | 3400.952 | 350 760 112 | 2.140 |
| 40 | GN | 1 ½ | 36 - 53 | 48 | 3400.954 | 350 760 117 | 2.140 |
| 40 | GN | 1 ½ | 45 - 65 | 55 | 3400.956 | 350 760 113 | 2.140 |
| 40 | GN | 1 ½ | 60 - 80 | 70 | 3400.958 | 350 760 114 | 2.140 |
| 50 | GN | 2 | 20 - 30 | 25 | 3400.960 | 350 760 011 | 3.510 |
| 50 | GN | 2 | 30 - 45 | 40 | 3400.962 | 350 760 012 | 3.510 |
| 50 | GN | 2 | 36 - 53 | 48 | 3400.964 | 350 760 017 | 3.510 |
| 50 | GN | 2 | 45 - 65 | 55 | 3400.966 | 350 760 013 | 3.510 |
| 50 | GN | 2 | 60 - 80 | 70 | 3400.968 | 350 760 014 | 3.510 |



JRGUMAT 3400

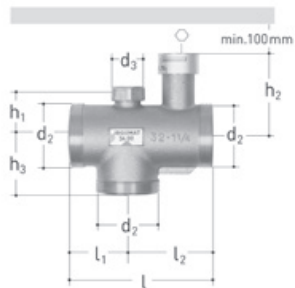

| DN (mm) | Thread Type | d2 G (inch) | d3 G (inch) | h1 (mm) | h2 (mm) | h3 (mm) | l (mm) | l1 (mm) | l2 (mm) | PN (bar) | ⬡ |
|------------|-------------|----------------|----------------|------------|------------|------------|-----------|------------|------------|-------------|---|
| 15 | GN | 1 1/8 | | | 47 | 35 | 90 | 35 | 55 | 10 | 5 |
| 15 | GN | 1 1/8 | | | 47 | 35 | 90 | 35 | 55 | 10 | 5 |
| 15 | GN | 1 1/8 | | | 47 | 35 | 90 | 35 | 55 | 10 | 5 |
| 15 | GN | 1 1/8 | | | 47 | 35 | 90 | 35 | 55 | 10 | 5 |
| 15 | GN | 1 1/8 | | | 47 | 35 | 90 | 35 | 55 | 10 | 5 |
| 20 | GN | 1 1/4 | 1/2 | 32 | 49 | 40 | 100 | 40 | 60 | 10 | 5 |
| 20 | GN | 1 1/4 | 1/2 | 32 | 49 | 40 | 100 | 40 | 60 | 10 | 5 |
| 20 | GN | 1 1/4 | 1/2 | 32 | 49 | 40 | 100 | 40 | 60 | 10 | 5 |
| 20 | GN | 1 1/4 | 1/2 | 32 | 49 | 40 | 100 | 40 | 60 | 10 | 5 |
| 20 | GN | 1 1/4 | 1/2 | 32 | 49 | 40 | 100 | 40 | 60 | 10 | 5 |
| 20 | GN | 1 1/4 | 1/2 | 32 | 49 | 40 | 100 | 40 | 60 | 10 | 5 |
| 25 | GN | 1 1/2 | 3/4 | 36 | 51 | 43 | 110 | 43 | 67 | 10 | 5 |
| 25 | GN | 1 1/2 | 3/4 | 36 | 51 | 43 | 110 | 43 | 67 | 10 | 5 |
| 25 | GN | 1 1/2 | 3/4 | 36 | 51 | 43 | 110 | 43 | 67 | 10 | 5 |
| 25 | GN | 1 1/2 | 3/4 | 36 | 51 | 43 | 110 | 43 | 67 | 10 | 5 |
| 25 | GN | 1 1/2 | 3/4 | 36 | 51 | 43 | 110 | 43 | 67 | 10 | 5 |
| 32 | GN | 2 | 3/4 | 41 | 75 | 52 | 130 | 52 | 78 | 10 | 8 |
| 32 | GN | 2 | 3/4 | 41 | 75 | 52 | 130 | 52 | 78 | 10 | 8 |
| 32 | GN | 2 | 3/4 | 41 | 75 | 52 | 130 | 52 | 78 | 10 | 8 |
| 32 | GN | 2 | 3/4 | 41 | 75 | 52 | 130 | 52 | 78 | 10 | 8 |
| 32 | GN | 2 | 3/4 | 41 | 75 | 52 | 130 | 52 | 78 | 10 | 8 |
| 40 | GN | 2 1/4 | 3/4 | 50 | 77 | 58 | 150 | 58 | 92 | 10 | 8 |
| 40 | GN | 2 1/4 | 3/4 | 50 | 77 | 58 | 150 | 58 | 92 | 10 | 8 |
| 40 | GN | 2 1/4 | 3/4 | 50 | 77 | 58 | 150 | 58 | 92 | 10 | 8 |
| 50 | GN | 2 3/4 | 3/4 | 60 | 85 | 70 | 180 | 70 | 110 | 10 | 8 |
| 50 | GN | 2 3/4 | 3/4 | 60 | 85 | 70 | 180 | 70 | 110 | 10 | 8 |
| 50 | GN | 2 3/4 | 3/4 | 60 | 85 | 70 | 180 | 70 | 110 | 10 | 8 |
| 50 | GN | 2 3/4 | 3/4 | 60 | 85 | 70 | 180 | 70 | 110 | 10 | 8 |
| 50 | GN | 2 3/4 | 3/4 | 60 | 85 | 70 | 180 | 70 | 110 | 10 | 8 |

JRGUMAT 3410

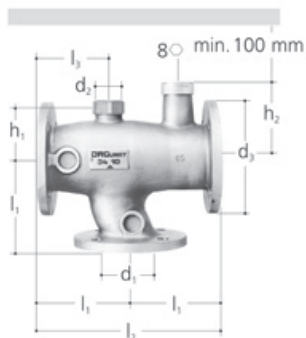

JRGUMAT Thermostatic mixing valve gunmetal Flanged

- Temperature: max. 90°C
- Factory setting: 25 / 40 / 48 / 55°C (adjustable)
- Material: gunmetal
- Connection: flange

| DN (mm) | d (mm) | range (°C) | Temperature (°C) | JRG Code | GF Code | Weight (kg) |
|------------|-----------|---------------|---------------------|-----------------|--------------------|----------------|
| 65 | 65 | 20 - 30 | 25 | 3410.601 | 350 767 214 | 22.500 |
| 65 | 65 | 30 - 45 | 40 | 3410.605 | 350 767 215 | 22.500 |
| 65 | 65 | 36 - 53 | 48 | 3410.606 | 350 767 218 | 22.680 |
| 65 | 65 | 45 - 65 | 55 | 3410.608 | 350 767 216 | 22.500 |
| 80 | 80 | 20 - 30 | 25 | 3410.801 | 350 767 414 | 27.500 |
| 80 | 80 | 30 - 45 | 40 | 3410.805 | 350 767 415 | 27.500 |
| 80 | 80 | 36 - 53 | 48 | 3410.806 | 350 767 418 | 27.734 |
| 80 | 80 | 45 - 65 | 55 | 3410.808 | 350 767 416 | 27.500 |

| DN (mm) | d1 (mm) | d2 G (inch) | d3 (mm) | h1 (mm) | h2 (mm) | l1 (mm) | l2 (mm) | l3 (mm) | ○ | ◇ | PN (bar) |
|------------|------------|----------------|------------|------------|------------|------------|------------|------------|---|---|-------------|
| 65 | 65 | 1 ½ | 185 | 82 | 121 | 145 | 290 | 112 | 4 | 8 | 10 |
| 65 | 65 | 1 ½ | 185 | 82 | 121 | 145 | 290 | 112 | 4 | 8 | 10 |
| 65 | 65 | 1 ½ | 185 | 82 | 121 | 145 | 290 | 112 | 4 | 8 | 10 |
| 65 | 65 | 1 ½ | 185 | 82 | 121 | 145 | 290 | 112 | 4 | 8 | 10 |
| 80 | 80 | 2 | 200 | 92 | 127 | 155 | 310 | 124 | 8 | 8 | 10 |
| 80 | 80 | 2 | 200 | 92 | 127 | 155 | 310 | 124 | 8 | 8 | 10 |
| 80 | 80 | 2 | 200 | 92 | 127 | 155 | 310 | 124 | 8 | 8 | 10 |
| 80 | 80 | 2 | 200 | 92 | 127 | 155 | 310 | 124 | 8 | 8 | 10 |

Unions

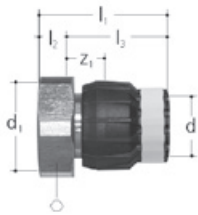

JRG Sanipex MT Transition union gunmetal

- Description: for JRG Sanipex d16/20, JRG Sanipex MT Pipes
- Material: gunmetal, plastic
- Connection: JRG Sanipex MT

Not suitable for direct connection to water meters, as replacement only possible with JRG Sanipex MT ratchet torque wrench.

| d | GN | JRG Code | GF Code | Weight | d1 G | l1 | l2 | l3 | z1 | ⊙ |
|------|--------|----------|-------------|--------|--------|-------|------|------|------|----|
| (mm) | (inch) | | | (kg) | (inch) | (mm) | (mm) | (mm) | (mm) | |
| 16 | ½ | 4700.096 | 351 616 992 | 0.068 | ½ | 43.0 | 6.0 | 37.0 | 16.5 | 27 |
| 20 | ½ | 4700.098 | 351 620 968 | 0.071 | ½ | 50.0 | 6.0 | 44.0 | 17.5 | 27 |
| 16 | ¾ | 4700.102 | 351 616 994 | 0.066 | ¾ | 39.0 | 6.0 | 33.0 | 14.5 | 32 |
| 20 | ¾ | 4700.104 | 351 620 992 | 0.070 | ¾ | 44.0 | 6.0 | 38.0 | 15.5 | 32 |
| 26 | ¾ | 4700.106 | 351 626 919 | 0.100 | ¾ | 57.0 | 6.0 | 49.0 | 20.0 | 32 |
| 16 | 1 ¼ | 4700.120 | 351 616 996 | 0.130 | 1 ¼ | 41.0 | 8.0 | 33.0 | 14.5 | 46 |
| 20 | 1 ¼ | 4700.122 | 351 620 994 | 0.130 | 1 ¼ | 46.0 | 8.0 | 38.0 | 15.5 | 46 |
| 26 | 1 ¼ | 4700.124 | 351 626 995 | 0.150 | 1 ¼ | 55.5 | 8.0 | 47.5 | 18.5 | 46 |
| 32 | 1 ¼ | 4700.126 | 351 632 995 | 0.200 | 1 ¼ | 65.5 | 8.0 | 57.5 | 19.5 | 46 |
| 26 | 1 ½ | 4700.128 | 351 626 996 | 0.200 | 1 ½ | 56.5 | 9.0 | 47.5 | 18.5 | 54 |
| 32 | 1 ½ | 4700.130 | 351 632 996 | 0.260 | 1 ½ | 66.5 | 9.0 | 57.5 | 19.5 | 54 |
| 40 | 1 ½ | 4700.132 | 351 640 995 | 0.330 | 1 ½ | 77.5 | 9.0 | 68.5 | 23.5 | 55 |
| 40 | 2 | 4700.136 | 351 640 996 | 0.420 | 2 | 82.5 | 13.5 | 69.0 | 24.5 | 67 |
| 50 | 2 ¼ | 4700.138 | 351 650 996 | 0.667 | 2 ¼ | 82.5 | 11.0 | 71.5 | 34.0 | 72 |
| 63 | 2 ¾ | 4700.142 | 351 663 996 | 1.050 | 2 ¾ | 100.0 | 13.5 | 86.5 | 40.0 | 89 |

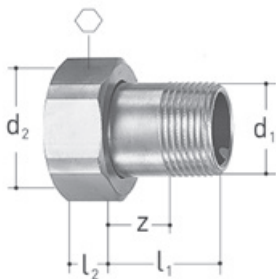

JRG Union brass

- Description: to 1684, 3400
- Material: brass
- Connection: female thread, male thread

| GN | DN | JRG Code | GF Code | Weight | d1 R | d2 G | l1 | l2 |
|--------|------|----------|-------------|--------|--------|--------|------|------|
| (inch) | (mm) | | | (kg) | (inch) | (inch) | (mm) | (mm) |
| ¾ | 10 | 8200.160 | 350 278 401 | 0.040 | ¾ | ½ | 22 | 6 |

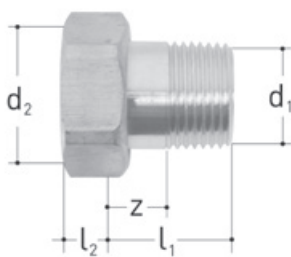

JRG Union brass

- Description: to 1300-1333, 1350-1363, 2100-2110, 2113, 2130-2140, 2143, 8201.402, 9601.040, 9603.040, 9606.040, 9695.480
- Material: brass
- Connection: male thread

| GN | DN | JRG Code | GF Code | Weight | d1 R | d2 G | l1 | l2 | z |
|--------|------|----------|-------------|--------|--------|--------|------|------|------|
| (inch) | (mm) | | | (kg) | (inch) | (inch) | (mm) | (mm) | (mm) |
| ½ | 15 | 8201.240 | 350 331 701 | 0.060 | ½ | ¾ | 25 | 6 | 12 |
| 1 ¼ | 32 | 8201.480 | 350 332 001 | 0.290 | 1 ¼ | 1 ½ | 38 | 9 | 18 |

Unions

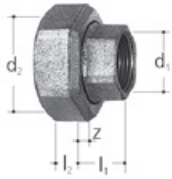

JRG Union malleable cast iron galvanized

- Description: to 1640, 1660-1663, 3400, 3410, 5130
- Material: malleable cast iron, galvanized
- Connection: female thread

| GN (inch) | DN (mm) | JRG Code | GF Code | Weight (kg) | d1 Rp (inch) | d2 G (inch) | l1 (mm) | l2 (mm) | z (mm) |
|--------------|------------|-------------|-------------|----------------|-----------------|----------------|------------|------------|-----------|
| ½ | 15 | 8204.240 | 350 485 601 | 0.150 | ½ | 1 ⅞ | 23 | 10 | 10 |
| ¾ | 20 | 8204.320 | 350 485 701 | 0.170 | ¾ | 1 ¼ | 24 | 11 | 9 |
| 1 | 25 | 8204.400 | 350 485 801 | 0.230 | 1 | 1 ½ | 27 | 11 | 10 |
| 1 ¼ | 32 | 8204.480 | 350 485 901 | 0.400 | 1 ¼ | 2 | 32 | 12 | 13 |
| 1 ½ | 40 | 8204.560 | 350 486 001 | 0.510 | 1 ½ | 2 ¼ | 34 | 13 | 15 |
| 2 | 50 | 8204.640 | 350 486 101 | 0.675 | 2 | 2 ¾ | 36 | 15 | 12 |

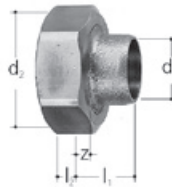

JRG Soldering union gunmetal

- Description: to 3400, 3410, 5120
- Material: gunmetal, brass
- * as long as stock last

| | d (mm) | DN (mm) | JRG Code | GF Code | Weight (kg) | d1 (mm) | d2 G (inch) | l1 (mm) | l2 (mm) | z (mm) |
|---|-----------|------------|-------------|-------------|----------------|------------|----------------|------------|------------|-----------|
| * | 18 | 15 | 8209.018 | 350 484 102 | 0.120 | 18 | 1 ⅞ | 23 | 8 | 8 |
| | 22 | 20 | 8209.022 | 350 484 201 | 0.175 | 22 | 1 ¼ | 24 | 8 | 7 |
| | 22 | 20 | 8209.122 | 355 630 901 | 0.250 | 22 | 1 ½ | 24 | 9 | 7 |
| | 28 | 25 | 8209.028 | 350 484 301 | 0.260 | 28 | 1 ½ | 26 | 9 | 6 |
| | 35 | 32 | 8209.035 | 350 484 401 | 0.380 | 35 | 2 | 33 | 9 | 8 |
| | 42 | 40 | 8209.042 | 350 484 601 | 0.500 | 42 | 2 ¼ | 37 | 11 | 8 |
| | 54 | 50 | 8209.054 | 350 484 801 | 0.730 | 54 | 2 ¾ | 42 | 14 | 8 |

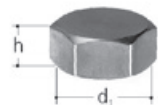

JRG Cap brass

- Description: to 3400, 3410
- Material: brass

| DN (mm) | Size (inch) | PN (bar) | GN (inch) | JRG Code | GF Code | Weight (kg) | d1 G (inch) | h (mm) |
|------------|----------------|-------------|--------------|-------------|-------------|----------------|----------------|-----------|
| 15 | ½ | 10 | ½ | 8325.240 | 350 756 701 | 0.034 | ½ | 9 |
| 20 | ¾ | 10 | ¾ | 8325.320 | 350 756 801 | 0.040 | ¾ | 9 |
| 40 | 1 ½ | 10 | 1 ½ | 8325.560 | 350 769 801 | 0.190 | 1 ½ | 11 |
| 50 | 2 | 10 | 2 | 8325.640 | 350 769 901 | 0.230 | 2 | 11 |

Unions

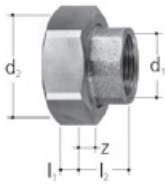

JRG Union gunmetal

- Description: to 3400, 3410, 5120
- Material: gunmetal
- Connection: female thread

| GN (inch) | DN (mm) | JRG Code | GF Code | Weight (kg) | d1 Rp (inch) | d2 G (inch) | l1 (mm) | l2 (mm) | z (mm) |
|--------------|------------|-----------------|--------------------|----------------|-----------------|----------------|------------|------------|-----------|
| ½ | 15 | 8331.240 | 350 217 101 | 0.150 | ½ | 1 ¼ | 8 | 23 | 10 |
| ¾ | 20 | 8331.320 | 350 253 301 | 0.150 | ¾ | 1 ¼ | 8 | 23 | 8 |
| 1 | 25 | 8331.400 | 350 253 401 | 0.230 | 1 | 1 ½ | 9 | 27 | 10 |
| 1 ¼ | 32 | 8331.480 | 350 253 501 | 0.380 | 1 ¼ | 2 | 10 | 29 | 10 |
| 1 ½ | 40 | 8331.560 | 350 253 601 | 0.460 | 1 ½ | 2 ¼ | 11 | 33 | 14 |
| 2 | 50 | 8331.640 | 350 253 701 | 0.740 | 2 | 2 ¾ | 14 | 36 | 12 |

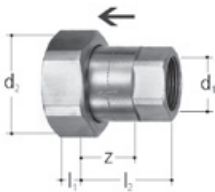

JRG Union gunmetal

- Description: to 3400
- Temperature: max. 90°C
- Material: gunmetal
- Connection: female thread
- Consisting of: back flow preventer, loose nut

| GN (inch) | DN (mm) | JRG Code | GF Code | Weight (kg) | d1 Rp (inch) | d2 G (inch) | l1 (mm) | l2 (mm) | z (mm) | PN (bar) |
|--------------|------------|-----------------|--------------------|----------------|-----------------|----------------|------------|------------|-----------|-------------|
| ½ | 15 | 8337.240 | 350 768 601 | 0.170 | ½ | 1 ¼ | 8 | 39 | 26 | 10 |
| ¾ | 20 | 8337.320 | 350 768 801 | 0.235 | ¾ | 1 ¼ | 8 | 45 | 30 | 10 |

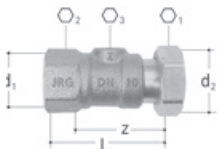

JRG union brass lead-free

- Description: 6320, 6325, 9910, 9920
- Temperature: max. 90°C
- Material: brass lead-free
- Connection: female thread
- Consisting of: ball valve, lockable, loose nut

| GN (inch) | DN (mm) | JRG Code | Weight (kg) | GF Code | d1 Rp (inch) | d2 G (inch) | l (mm) | Ø1 (mm) | Ø2 (mm) | Ø3 (mm) | z (mm) | PN (bar) |
|--------------|------------|-----------------|----------------|--------------------|-----------------|----------------|-----------|------------|------------|------------|-----------|-------------|
| ½ | 15 | 8339.240 | 0.160 | 350 887 712 | ½ | ¾ | 58 | 30 | 27 | 5 | 47 | 16 |
| ¾ | 20 | 8339.320 | 0.250 | 350 887 912 | ¾ | 1 | 62 | 38 | 31 | 5 | 49 | 16 |

Unions

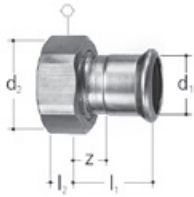

Mapress Union

- Description: to 1303, 1313, 1323, 1333, 1353, 1363, 1611, 1621, 2100-2140, 2161, 5010, 5015080, 5081, 5211, 5281, 6320, 9910, 9920
- Connection: Mapress
- Consisting of: loose nut, press-socket, flat sealed

| d1 (mm) | DN (mm) | JRG Code | GF Code | Weight (kg) | d2 G (inch) | l1 (mm) | l2 (mm) | z (mm) | ⊙ |
|------------|------------|-------------|-------------|----------------|----------------|------------|------------|-----------|----|
| 15 | 12 | 8350.015 | 355 600 201 | 0.080 | ¾ | 31 | 7 | 11 | 30 |
| 18 | 15 | 8350.018 | 355 600 207 | 0.100 | ¾ | 31 | 7 | 12 | 30 |

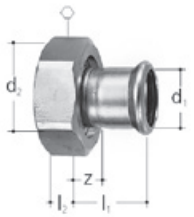

Mapress Union

- Description: to 1503, 1643, 1663, 2170, 3400, 5103, 5120, 5133, 5085, 5086
- Connection: Mapress
- Consisting of: loose nut, press-socket, flat sealed

| d1 (mm) | DN (mm) | JRG Code | GF Code | Weight (kg) | d2 G (inch) | l1 (mm) | l2 (mm) | z (mm) | ⊙ |
|------------|------------|-------------|-------------|----------------|----------------|------------|------------|-----------|----|
| 18 | 15 | 8351.018 | 355 600 407 | 0.157 | 1 ¼ | 39 | 8 | 18 | 46 |
| 22 | 20 | 8351.022 | 355 600 402 | 0.140 | 1 ¼ | 42 | 8 | 21 | 46 |
| 22 | 20 | 8351.122 | 355 600 408 | 0.208 | 1 ½ | 42 | 9 | 21 | 54 |
| 28 | 25 | 8351.028 | 355 600 403 | 0.210 | 1 ½ | 44 | 9 | 21 | 54 |
| 35 | 32 | 8351.035 | 355 600 404 | 0.350 | 2 | 49 | 11 | 23 | 66 |
| 42 | 40 | 8351.042 | 355 600 405 | 0.413 | 2 ¼ | 52 | 11 | 22 | 72 |
| 54 | 50 | 8351.054 | 355 600 406 | 0.610 | 2 ¾ | 57 | 14 | 22 | 89 |

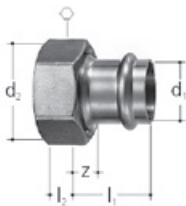

Optipress Union

- Description: to 1303, 1313, 1323, 1333, 1353, 1363, 1611, 1621, 2100-2140, 2161, 5010, 5015080, 5081, 5211, 5281, 6320, 9910, 9920
- Connection: Optipress / Sanpress
- Consisting of: loose nut, press-socket, flat sealed

| d1 (mm) | DN (mm) | JRG Code | GF Code | Weight (kg) | d2 G (inch) | l1 (mm) | l2 (mm) | z (mm) | ⊙ |
|------------|------------|-------------|-------------|----------------|----------------|------------|------------|-----------|----|
| 15 | 12 | 8355.015 | 355 600 601 | 0.100 | ¾ | 37 | 9 | 13 | 31 |
| 18 | 15 | 8355.018 | 355 600 602 | 0.080 | ¾ | 40 | 9 | 16 | 31 |
| 22 | 20 | 8355.022 | 355 600 603 | 0.110 | 1 | 39 | 9 | 15 | 37 |
| 28 | 25 | 8355.028 | 355 600 604 | 0.170 | 1 ¼ | 42 | 11 | 18 | 46 |
| 35 | 32 | 8355.035 | 355 600 605 | 0.210 | 1 ½ | 44 | 13 | 18 | 53 |
| 42 | 40 | 8355.042 | 355 600 606 | 0.360 | 1 ¾ | 61 | 13 | 20 | 60 |
| 54 | 50 | 8355.054 | 355 600 607 | 0.540 | 2 ¾ | 61 | 16 | 15 | 78 |

Unions

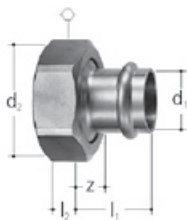

Optipress Union

- Description: to 1503, 1643, 1663, 2170, 3400, 5015, 5016, 5103, 5120, 5133, 5085, 5086
- Connection: Optipress / Sanpress
- Consisting of: loose nut, press-socket, flat sealed

| d1 (mm) | DN (mm) | JRG Code | GF Code | Weight (kg) | d2 G (inch) | l1 (mm) | l2 (mm) | z (mm) | ⊘ |
|------------|------------|-------------|-------------|----------------|----------------|------------|------------|-----------|----|
| 15 | 12 | 8356.015 | 355 600 801 | 0.132 | 1 1/8 | 39 | 10 | 15 | 42 |
| 18 | 15 | 8356.018 | 355 600 808 | 0.180 | 1 1/4 | 40 | 9 | 18 | 46 |
| 22 | 20 | 8356.022 | 355 600 802 | 0.250 | 1 1/4 | 36 | 11 | 12 | 50 |
| 22 | 20 | 8356.122 | 355 600 807 | 0.180 | 1 1/2 | 36 | 9 | 12 | 52 |
| 28 | 25 | 8356.028 | 355 600 803 | 0.190 | 1 1/2 | 38 | 12 | 14 | 52 |
| 35 | 32 | 8356.035 | 355 600 804 | 0.280 | 2 | 39 | 12 | 15 | 64 |
| 42 | 40 | 8356.042 | 355 600 805 | 0.580 | 2 1/4 | 48 | 12 | 12 | 73 |
| 54 | 50 | 8356.054 | 355 600 806 | 0.640 | 2 3/4 | 62 | 17 | 15 | 88 |

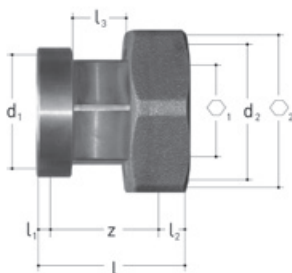

JRG Socket connection gunmetal

- Description: to 1611, 1631, 2191, 3400, 5120, 5211, 5281
- Material: gunmetal
- Connection: female thread
- Consisting of: loose nut, press-socket, flat sealed

| Size (inch) | DN (mm) | PN (bar) | JRG Code | GF Code | Weight (kg) |
|----------------|------------|-------------|-------------|-------------|----------------|
| 1/2 | 15 | 16 | 8360.015 | 351 061 403 | 0.219 |
| 3/4 | 20 | 16 | 8360.020 | 351 061 413 | 0.300 |
| 1 | 25 | 16 | 8360.025 | 351 061 423 | 0.451 |
| 1 1/4 | 32 | 16 | 8360.032 | 351 061 433 | 0.670 |
| 1 1/2 | 40 | 16 | 8360.040 | 351 061 443 | 0.730 |
| 2 | 50 | 16 | 8360.050 | 351 061 453 | 1.170 |

| d1 G (inch) | d2 G (inch) | l (mm) | l1 (mm) | l2 (mm) | l3 (mm) | ⊘1 | ⊘2 | z (mm) |
|----------------|----------------|-----------|------------|------------|------------|----|----|-----------|
| 3/4 | 1 1/8 | 56 | 6 | 8 | 22 | 22 | 41 | 42 |
| 1 | 1 1/4 | 57 | 7 | 8 | 22 | 27 | 46 | 42 |
| 1 1/4 | 1 1/2 | 61 | 8 | 9 | 22 | 32 | 54 | 44 |
| 1 1/2 | 2 | 65 | 9 | 9 | 22 | 41 | 66 | 47 |
| 1 3/4 | 2 1/4 | 68 | 10 | 11 | 22 | 48 | 72 | 48 |
| 2 3/8 | 2 3/4 | 74 | 11 | 14 | 22 | 58 | 89 | 49 |

Accessories

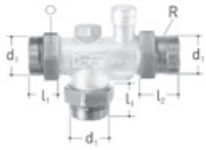

JRGUMAT change over set gunmetal

- Material: gunmetal
- Transition JRGUMAT 3350 to 3400
- R = DN 40 and 50 two half rings – see assembly instructions

| DN (mm) | Thread Type | Size (inch) | JRG Code | GF Code | Weight (kg) | d1 G (inch) | l1 (mm) | l2 (mm) |
|------------|-------------|----------------|-------------|-------------|----------------|----------------|------------|------------|
| 20 | GN | ¾ | 3480.320 | 350 597 601 | 0.490 | 1 ¼ | 30.5 | 40.5 |
| 25 | GN | 1 | 3480.400 | 350 597 701 | 0.800 | 1 ½ | 38.0 | 34.0 |
| 32 | GN | 1 ¼ | 3480.480 | 350 597 801 | 1.050 | 2 | 39.5 | 33.5 |
| 40 | GN | 1 ½ | 3480.560 | 350 597 901 | 1.250 | 2 ¼ | 44.5 | 30.5 |
| 50 | GN | 2 | 3480.640 | 350 598 001 | 1.715 | 2 ¾ | 44.5 | 34.5 |

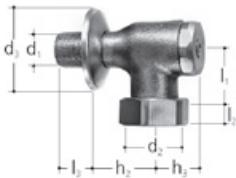

JRG Corner union gunmetal

- Material: gunmetal
- Connection: inlet male thread, outlet loose nut

| GN (inch) | DN (mm) | JRG Code | GF Code | Weight (kg) |
|--------------|------------|-------------|-------------|----------------|
| ½ | 15 | 8341.240 | 350 759 902 | 0.433 |

| GN (inch) | DN (mm) | d1 R (inch) | d2 G (inch) | d3 (mm) | h2 (mm) | h3 (mm) | l1 (mm) | l2 (mm) | l3 (mm) | PN (bar) |
|--------------|------------|----------------|----------------|------------|------------|------------|------------|------------|------------|-------------|
| ½ | 15 | ½ | 1 ¼ | 65 | 35 | 32 | 40 | 8 | 25 | 10 |

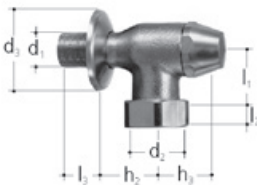

JRG Corner valve gunmetal

- Material: gunmetal
- Connection: inlet male thread, outlet loose nut

| GN (inch) | DN (mm) | JRG Code | GF Code | Weight (kg) |
|--------------|------------|-------------|-------------|----------------|
| ½ | 15 | 8347.240 | 350 759 901 | 0.480 |

| GN (inch) | DN (mm) | d1 R (inch) | d2 G (inch) | d3 (mm) | h2 (mm) | h3 (mm) | l1 (mm) | l2 (mm) | l3 (mm) | PN (bar) |
|--------------|------------|----------------|----------------|------------|------------|------------|------------|------------|------------|-------------|
| ½ | 15 | ½ | 1 ¼ | 65 | 35 | 48 | 40 | 8 | 25 | 10 |

Accessories

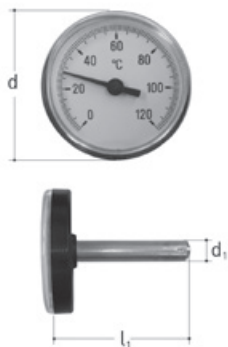

JRG Thermometer brass

- Description: to 8348.080
- Material: brass, plastic

| d (mm) | JRG Code | GF Code | Weight (kg) | d1 (mm) | l1 (mm) |
|-----------|-----------------|--------------------|----------------|------------|------------|
| 52 | 8348.001 | 350 830 194 | 0.030 | 9 | 62 |

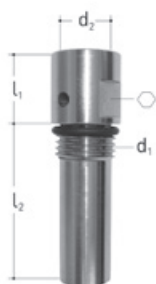

JRG Sleeve stainless steel

- Description: to 3500, 3510, 6325
- Material: stainless steel, EPDM

| GN (inch) | DN (mm) | JRG Code | GF Code | Weight (kg) | d1 G (inch) | d2 (mm) | l1 (mm) | l2 (mm) | ⊘ |
|--------------|------------|-----------------|--------------------|----------------|----------------|------------|------------|------------|----|
| ¼ | 8 | 8348.080 | 350 830 192 | 0.030 | ¼ | 9 | 15 | 35 | 13 |

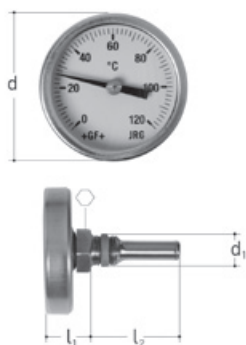

JRG Thermometer stainless steel

- Description: to 3500, 3510, 6325
- Material: stainless steel

| GN (inch) | DN (mm) | JRG Code | GF Code | Weight (kg) | d (mm) | d1 G (inch) | l1 (mm) | l2 (mm) | ⊘ |
|--------------|------------|-----------------|--------------------|----------------|-----------|----------------|------------|------------|----|
| ¼ | 8 | 8349.080 | 350 830 191 | 0.080 | 52 | ¼ | 19 | 35 | 17 |

Spare Parts

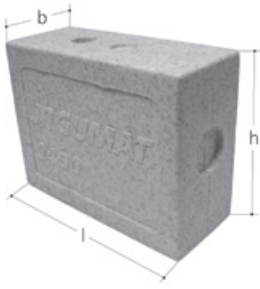

JRGUMAT Insulation box EPS

- Material: EPS

| GN (inch) | DN (mm) | GF Code | Weight (kg) | l (mm) | b (mm) | h (mm) |
|--------------|------------|-------------|----------------|-----------|-----------|-----------|
| ½ | 15 | 350 762 301 | 0.043 | 170 | 74 | 140 |
| ¾ | 20 | 350 762 201 | 0.043 | 190 | 80 | 150 |
| 1 | 25 | 350 762 101 | 0.068 | 190 | 90 | 145 |
| 1 ¼ | 32 | 350 762 001 | 0.096 | 221 | 100 | 180 |
| 1 ½ | 40 | 350 761 901 | 0.110 | 250 | 104 | 195 |
| 2 | 50 | 350 761 801 | 0.210 | 290 | 125 | 220 |

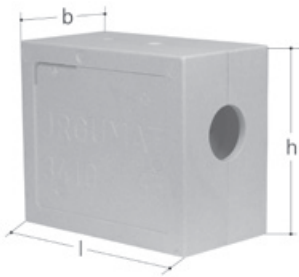

JRGUMAT Insulation box EPS

- Material: EPS

| GN (inch) | DN (mm) | GF Code | Weight (kg) | l (mm) | b (mm) | h (mm) |
|--------------|------------|-------------|----------------|-----------|-----------|-----------|
| 2 ½ | 65 | 350 767 701 | 0.476 | 395 | 335 | 220 |
| 3 | 80 | 350 767 801 | 0.238 | 420 | 355 | 230 |



JRGUMAT Gasket set AFM34 For 3400

- Material: AFM34

| GN (inch) | JRG Code | GF Code | Weight (kg) |
|--------------|----------|-------------|----------------|
| ½ | 3415.240 | 350 760 510 | 0.010 |
| ¾ | 3415.320 | 350 760 410 | 0.012 |
| 1 | 3415.400 | 350 760 310 | 0.015 |
| 1 ¼ | 3415.480 | 350 760 210 | 0.020 |
| 1 ½ | 3415.560 | 350 760 110 | 0.025 |
| 2 | 3415.640 | 350 760 010 | 0.028 |



Local support around the world

Visit our webpage to get in touch with your local specialist:
www.gfps.com/our-locations



The information and technical data (altogether "Data") herein are not binding, unless explicitly confirmed in writing. The Data neither constitutes any expressed, implied or warranted characteristics, nor guaranteed properties or a guaranteed durability. All Data is subject to modification. The General Terms and Conditions of Sale of Georg Fischer Piping Systems apply.

gfps-3724262-brochure-jrgumat-en
e / 09.23 / IH
© Georg Fischer JRG AG
Hauptstrasse 130
CH-4450 Sissach/Switzerland
Telefon +41 (0) 61 975 22 22
info.jrg.ps@georgfischer.com
Printed in Switzerland